



Pictures top: Container version
 Pictures middle: Beverage version
 Pictures bottom: Container version, CNG version, Beverage version

Standard Equipment/Optional Equipment

Standard Equipment

Linde twin drive pedals to control forward/reverse travel and braking
 Original Linde Load Control integrated in armrest
 Hydraulic suspended comfort-class seat with extensive range of adjustment
 Hydrostatic steering, kickback free
 High safety and stability ensured by Linde ProtectorFrame
 Anti-glare display with fuel gauge, clock, hour meter and service information
 Control lights on display for engine oil pressure, engine overheating, parking brake, audible warning signal for engine and hydraulic oil temperature, blocked intake filter and low fuel level
 Plenty of storage space for writing utensils, beverage cans...
 Air intake filter with integrated cyclone separator
 High-performance hydraulic filter concept, guarantees maximum oil purity and extends life of all hydraulic components
 LPG truck fitted with a two-way catalytic converter
 The mounting of the gas bottle is ergonomically designed for easy changing

Optional Equipment

Single drive pedal with direction selector on armrest
 Overhead guard can be upgraded to full cabine with roof, front and rear screens and doors (also available with tinted glass)
 Wiper-washers for front, rear and roof screens
 Further seats with additional comfort and adjustments
 Cab heater with integrated pollen filter
 Air Conditioning
 Radio or DAB+ radio
 Sun screens, illuminated clipboard, interior lighting, height adjustable steering column, terminal support
 Standard masts from 3,000 mm to 5,400 mm lift
 Duplex masts (full free lift) from 2,700 mm to 4,130 mm lift
 Triplex masts (full free lift) from 4,525 mm to 6,315 mm lift
 Integrated sideshift
 Integrated fork positioner
 Load backrest
 One or two auxiliary hydraulic circuits for all mast types

LPG truck fitted with accurate ultrasonic fuel level indicator for exchange bottles
 LPG volumetric fuel tank version with fuel level indicator at the display
 Superelastic tyres

New STANDARD features for the Evo models:

Variable displacement pump for best energy consumption
 Integrated diesel particulate filter for EU models with 55 kW
 New seat/armrest generation for outstanding ergonomics
 LEPS (Linde-Engine-Protection-System) as monitoring of motor oil pressure and level, temperature and level of the cooling water and temperature of the hydraulic oil
 Curve Assist for automatic speed adaption
 Intelligent drive dynamic modi now integrate lift hydraulic
 New development timing belt protection
 Enhanced steering axle
 Handhold for safe access at A-pillar

Alternative fork lengths
 Tilt cylinder- and roof protection
 Truck lighting, working lamps
 Audible reversing alarm, flasher and strobe beacons
 Mirrors
 Seat belt monitoring
 Linde original Blue Spot
 Camera and colour monitor
 Road traffic specifications
 Air precleaner
 Oilbath air precleaner
 Volumetric tank (LPG) with capacities of 70 l
 3-way catalytic converter (LPG)
 Unregulated catalyst (Diesel)
 CNG (natural gas) version
 Connected Solutions
 Custom paintwork

Other options available on request



Diesel, LPG and CNG Forklift Trucks
 Capacity 4000 - 5000 kg
 H40/500 *EVO*®, H45/500 *EVO*®,
 H50/500 *EVO*®, H50/600 *EVO*®^{394_02}



Safety

Linde ProtectorFrame: The protective overhead guard and its supporting frame together form a strong protective zone providing optimum safety and protection for the operator. Top-mounted tilt cylinders provide seamless and smooth control of the tilt movements for excellent load stability in all operating conditions. This unique design also enables slimmer mast profiles to be fitted for outstanding visibility.

Performance

Low consumption and exhaust level and nevertheless this truck range continues to impress with its excellent performance. Advanced engine and drive technology combined with the original Linde Load Control system enables the operator to use the trucks vast potential to maximise productivity. Precise fingertip control of all mast functions.

Comfort

Step in relaxed, leave again relaxed. Linde brings to this forklift a generously sized automobile-class workspace. A perfect interface between operator and truck has been achieved with the Linde ergonomic design concept. The spacious cab, comfort-class seat with adjustable armrest and intuitive controls allow fast and stress-free working.

Reliability

Proven in tough applications. Decoupling of mast and drive axle with chassis and cabine results in reduced shock and vibration. The enclosed robot-welded chassis is designed for maximum strength and durability. The resilient, maintenance-free mountings of the axles and tilt jacks cut downtime and operating costs.

Productivity

50 years of permanent optimisation of the original Linde hydraulic system leads to effective and cost-efficient work: The original Linde hydrostatic transmission requires no differential, no drum brake, no gearshift and no clutch. As a result, uptime is optimised, productivity is increased and maintenance costs are low.

Features



Linde twin accelerator pedals

→ Fast and smooth travel direction changes without constantly moving feet from one pedal to the other
 → Short pedal travel
 → No strain on ankles or legs
 → Operator maintains high efficiency levels

Linde Load Control

→ Mini levers for all mast functions mounted on an adjustable armrest
 → Precise and effortless fingertip control of all mast functions for safe, efficient load handling
 → Engine rpm is automatically synchronised to precisely match hydraulic demands

High-economy engine technology

→ Modern, advanced technology Diesel, LPG and CNG engines matched to Linde's demanding requirements
 → High torque for impressive and flexible performance
 → Extremely fuel efficient
 → Exhaust emissions significantly below the approved European limits



Linde operator compartment

→ Advanced functional design for optimum operator comfort and efficiency
 → Superb working environment with spacious leg and headroom
 → Excellent visibility of the load and surrounding environment through slim-line profile mast sections
 → Resilient mounting of mast and drive axle absorbs road shocks and vibrations
 → Quiet, stress-free working

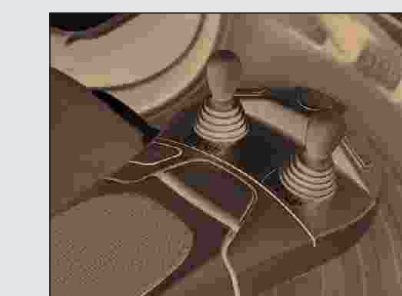

Variable displacement pump

→ For mast functions and additional hydraulic circuits
 → Electrically controlled by Linde Load Control levers
 → The Linde pump only provides the required oil volume
 → Lower fuel consumption
 → Less noise
 → Extended oil change intervals



Linde clear-view mast

→ Superb visibility through the slim profile mast sections
 → Full load capacity available up to maximum lift height
 → Excellent residual capacities
 → Maintenance-free resilient rubber mounting of mast/drive axle and tilt jacks
 → Electronic control of tilt angle
 → Electronic cushioning of end travel for forward/back tilt

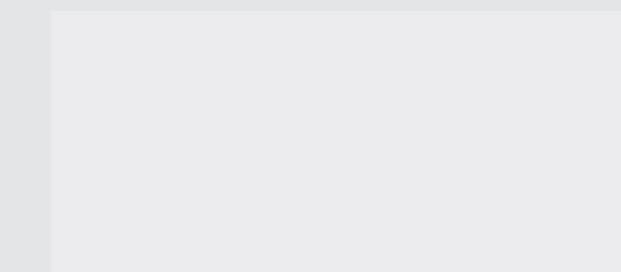

Linde Material Handling GmbH, Postfach 10 01 36, 63701 Aschaffenburg, Germany
 Phone +49.60 21.99-0, Fax +49.60 21.99-15 70, www.linde-mh.com, info@linde-mh.com



Subject to modification in the interest of progress. Illustrations and technical details could include options and not binding for actual constructions. All dimensions subject to usual tolerances.

Printed in Germany 144.c.3.1215.indd4

Technical Data according to VDI 2198

Characteristics	Linde Forklift Models												
	1.1	1.2	1.2a	1.3	1.4	1.5	1.6	1.8	1.9	2.1	2.2	2.3	2.3
Manufacturer	LINDE												
Model designation	H40D H45D H50/500D H50/600D H40T H45T H50/500T H50/600T H50/5000-Container ¹⁾ H50/5000 Beverage ²⁾ H50/500 CNG ³⁾												
Series	394-02												
Power unit	Diesel Diesel Diesel Diesel LPG LPG Diesel Diesel CNG												
Operation	Seat Seat Seat Seat Seat Seat Seat Seat Seat Seat												
Load capacity/Load	4.0 4.5 4.99 4.99 4.0 4.5 4.99 4.99 4.99 4.99 4.99												
Load centre	500 500 500 600 500 600 500 500 500 500 500												
Axle centre to fork face	483 525 535 535 483 525 535 493 535 535												
Wheelbase	1998 2038 2078 2078 1998 2038 2078 2078 2078 2078												
Service weight	5785 6295 6580 6947 5965 6480 6765 7132 6640 6790 6765												
Axle load with load, front/rear	8608 / 1177 9553 / 1242 10355 / 1215 10605 / 1332 8663 / 1302 9613 / 1367 10410 / 1345 10660 / 1462 10321 / 1309 10516 / 1264 10410 / 1345												
Axle load without load, front/rear	2640 / 3145 2790 / 3505 2880 / 3700 2889 / 4058 2695 / 3270 2850 / 3630 2935 / 3830 2944 / 4188 2946 / 3694 3041 / 3749 2935 / 3830												
Tyres rubber, SE, pneumatic, polyurethane	SE SE SE SE SE SE SE SE SE SE												
Tyre size, front	250/70-15 (250-15) 315/70-15 (300-15) 315/70-15 (300-15) 315/70-15 (300-15) 250/70-15 (250-15) 315/70-15 (300-15) 315/70-15 (300-15) 315/70-15 (300-15) 355/45-15 (28x12.5-15) 315/70-15 (300-15) 315/70-15 (300-15)												
Tyre size, rear	250/70-15 (250-15) 250/70-15 (250-15) 250/70-15 (250-15) 250/70-15 (250-15) 250/70-15 (250-15) 250/70-15 (250-15) 250/70-15 (250-15) 250/70-15 (250-15) 250/70-15 (250-15) 250/70-15 (250-15) 250/70-15 (250-15)												
Wheels, number front/rear (x = driven)	2x / 2 2x / 2 2x / 2 2x / 2 2x / 2 2x / 2 2x / 2 2x / 2 2x / 2 2x / 2 2x / 2												
Track width, front	1190 1190 1190 1190 1190 1190 1190 1190 1190 1190 1190												
Track width, rear	1122 1122 1122 1122 1122 1122 1122 1122 1122 1122 1122												
Mast/fork carriage tilt, forward/backward	5.0 / 9.0 ⁴⁾ 5.0 / 9.0 ⁴⁾ 5.0 / 9.0 ⁴⁾ 5.0 / 9.0 ⁴⁾ 5.0 / 9.0 ⁴⁾ 5.0 / 9.0 ⁴⁾ 5.0 / 9.0 ⁴⁾ 5.0 / 9.0 ⁴⁾ 5.0 / 7.5 ⁴⁾ 4.0 / 9.0 ⁴⁾ 5.0 / 9.0 ⁴⁾												
Height of mast, lowered	2421 ⁵⁾ 2421 ⁵⁾ 2421 ⁵⁾ 2421 ⁵⁾ 2370 ⁵⁾ 2421 ⁵⁾ 2421 ⁵⁾ 2421 ⁵⁾ 2160 2772 ⁵⁾ 2421 ⁵⁾												
Free lift	150 150 150 150 150 150 150 150 1310 150 150												
Lift	3000 3000 3000 2800 3000 3000 3000 3000 4045 3800 3000												
Height of mast, extended	3795 3916 3916 3816 3795 3916 3916 3816 4895 4716 3916												
Height of overhead guard (cabin)	2383 2416 2416 2416 2383 2416 2416 2416 2220 2816 2416												
Height of seat/stand on platform	1264 1264 1264 1264 1264 1264 1264 1264 1151 1664 1264												
Towing coupling height	703 726 719 718 703 726 719 718 733 719 719												
Overall length	3984 4066 4116 4396 3984 4066 4116 4396 4074 4116 4116												
Length to fork face	2984 3066 3116 3196 2984 3066 3116 3196 3074 3116 3116												
Overall width	1446 / 1423 1448 / 1423 1448 / 1423 1448 / 1423 1446 / 1423 1448 / 1423 1448 / 1423 1448 / 1423 1487 / 1423 1448 / 1423 1448 / 1423												
Fork dimensions	s/e/l (mm) 50 x 120 x 1000 50 x 120 x 1000 60 x 130 x 1000 60 x 130 x 1200 50 x 120 x 1000 50 x 120 x 1000 60 x 130 x 1000 60 x 130 x 1200 60 x 130 x 1000 60 x 130 x 1000 60 x 130 x 1000												
Fork carriage to ISO 2328, class/type A, B	3A 3A 3A 3A 3A 3A 3A 3A 3A 3A 3A												
Width of fork carriage	1350 1350 1350 1350 1350 1350 1350 1350 1350 1350 1350												
Ground clearance, below mast	203 205 203 203 158 205 203 203 146 203 203												
Ground clearance, centre of wheelbase	201 236 235 234 201 236 235 234 207 235 235												
Aisle width with pallet 1000 x 1200 across forks	4355 ⁶⁾ 4433 ⁶⁾ 4480 ⁶⁾ 4560 ⁶⁾ 4355 ⁶⁾ 4433 ⁶⁾ 4480 ⁶⁾ 4560 ⁶⁾ 4438 ⁶⁾ 4480 ⁶⁾ 4480 ⁶⁾												
Aisle width with pallet 800 x 1200 along forks	4633 ⁶⁾ 4633 ⁶⁾ 4680 ⁶⁾ 4760 ⁶⁾ 4555 ⁶⁾ 4555 ⁶⁾ 4638 ⁶⁾ 4760 ⁶⁾ 4680 ⁶⁾ 4680 ⁶⁾ 4680 ⁶⁾												
Turning radius	2672 2708 2745 2825 2672 2708 2745 2825 2745 2745 2745												
Minimum pivoting point distance	700 700 700 700 700 700 700 700 700 700 700												
Travel speed, with/without load	21 / 21 24 / 24 24 / 24 24 / 24 21 / 21 24 / 24 24 / 24 24 / 24 20 / 20 24 / 24 24 / 24												
Lifting speed, with/without load	0.53 / 0.57 0.53 / 0.57 0.49 / 0.53 0.49 / 0.53 0.53 / 0.57 0.53 / 0.57 0.49 / 0.53 0.49 / 0.53 0.49 / 0.53 0.49 / 0.53 0.49 / 0.53												
Lowering speed, with/without load	0.56 / 0.53 0.56 / 0.53 0.54 / 0.51 0.54 / 0.51 0.56 / 0.53 0.56 / 0.53 0.54 / 0.51 0.54 / 0.51 0.54 / 0.51 0.54 / 0.51 0.54 / 0.51												
Tractive force, with/without load	28541 / 20570 25285 / 21841 25285 / 22375 25285 / 22673 28540 / 21160 25285 / 22350 25285 / 23040 25285 / 23105 30202 / 23120 25064 / 23866 25285 / 23040												
Climbing ability, with/without load	29.0 / 34.0 22.0 / 32.0 21.0 / 32.0 20.0 / 30.0 28.0 / 33.0 22.0 / 32.0 20.0 / 32.0 19.0 / 30.0 28.0 / 36.0 22.0 / 36.0 20.0 / 32.0												
Acceleration time, with/without load	5.5 / 4.8 5.6 / 4.9 5.7 / 5.0 5.8 / 5.1 5.4 / 4.8 5.5 / 4.9 5.6 / 5.0 5.7 / 5.1 5.7 / 5.0 5.7 / 5.0 5.6 / 5.0												
Service brake	hydrostatic hydrostatic hydrostatic hydrostatic hydrostatic hydrostatic hydrostatic hydrostatic hydrostatic hydrostatic hydrostatic hydrostatic												
Engine manufacturer /type	VW CPYA VW CPYA VW CPYA VW CPYA VW CWTA VW CWTA VW CWTA VW CPYA VW CPYA VW CWTA												
Engine performance according to ISO 1585	55 55 55 55 56 55 55 55 55 55 55												
Rated speed	2700 2700 2700 2700 2700 2700 2700 2700 2700 2700 2700												
Number of cylinders/displacement	4 / 1968 4 / 1968 4 / 1968 4 / 1968 6 / 3597 6 / 3597 6 / 3597 6 / 3597 4 / 1968 4 / 1968 6 / 3597												
Fuel consumption according to VDI cycle	4.4 4.4 4.6 4.7 - 4.5 4.5 4.6 4.6 4.6 4.6												
Fuel consumption according to VDI cycle	- - - - 3.9 4.1 4.3 4.4 - - -												
Fuel consumption according to VDI cycle	- - - - 5.4 (H); 5.8 (L) ⁷⁾ - - -												
Type of drive control	LTC LTC LTC LTC LTC LTC LTC LTC LTC LTC LTC												
Operating pressure for attachments	170 170 170 170 170 170 170 170 170 170 170												
Oil flow for attachments	48 48 48 48 48 48 48 48 48 48 48												
Noise level at operator's ear	79 79 79 79 77 77 77 77 79 79 77												
towing coupling, design/type, DIN 15 170	similar to form H similar to form H similar to form H similar to form H similar to form H similar to form H similar to form H similar to form H similar to form H similar to form H similar to form H												

1) Technical specifications for LPG version or other tonnage like H40/45 on request
 2) Technical specifications for LPG version upon request
 3) Technical specifications for H40/45 on request
 4) Lift height and equipment can alter rear mast tilt angle
 5) With 150 mm free lift on standard mast
 6) Including a 200 mm (min.) operating aisle clearance.
 7) (H)= high quality, (L)= low quality

Lifting capacity diagrams

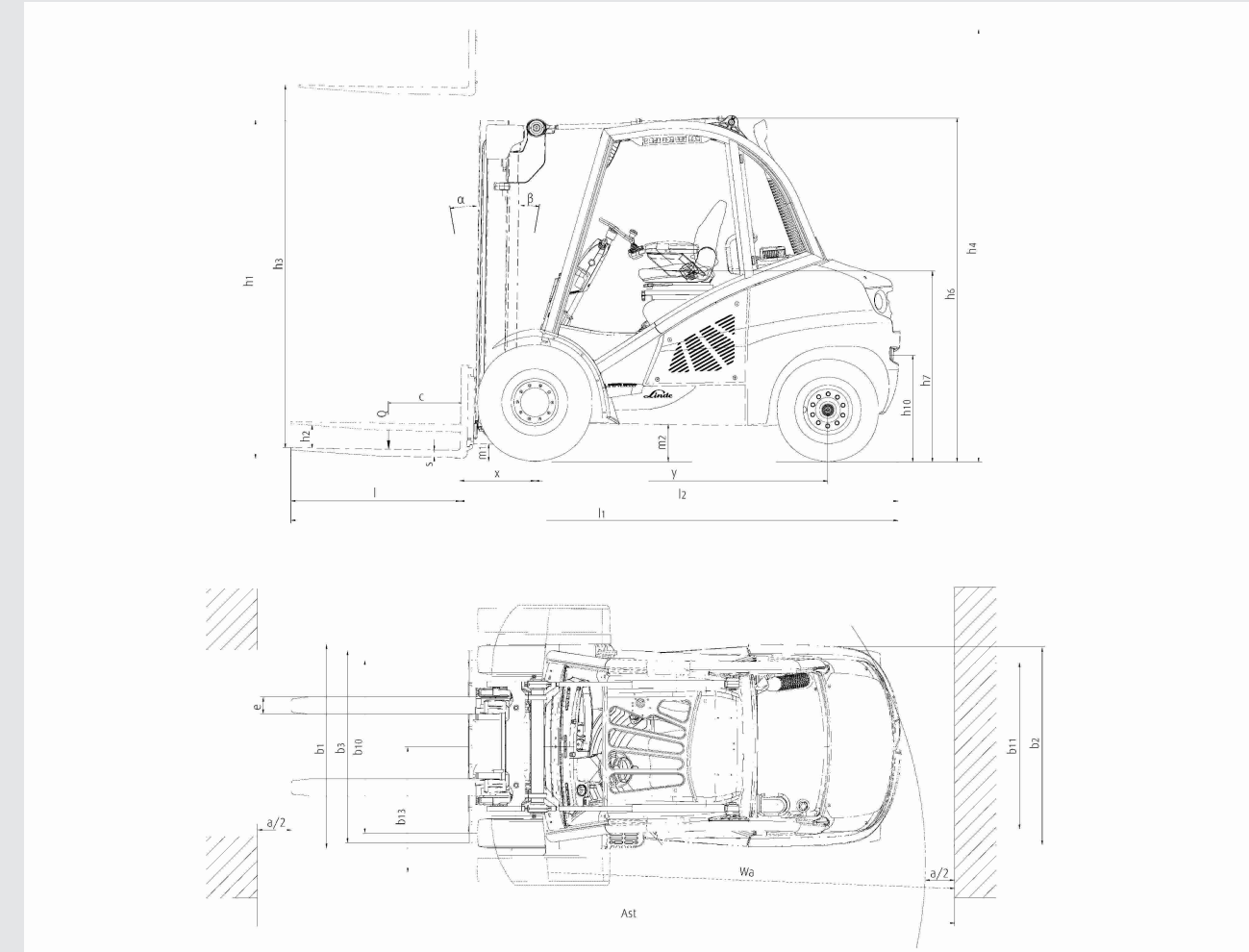
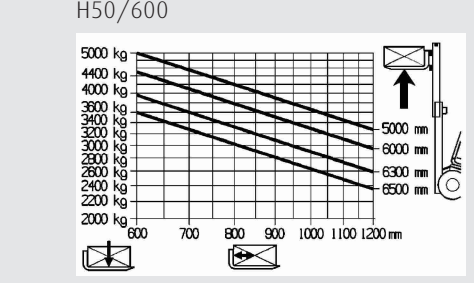
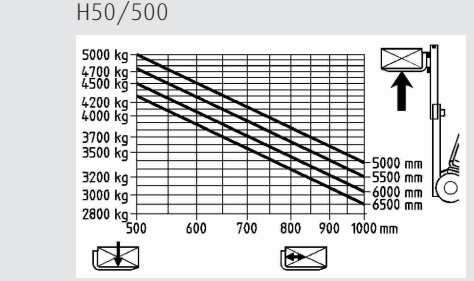
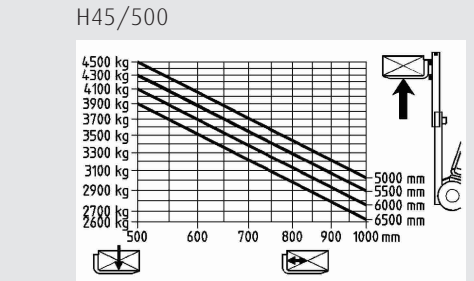
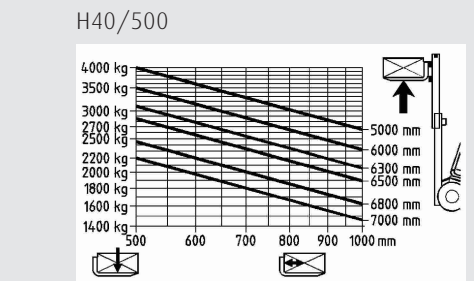

Overall height and lift height Standard mast (in mm)									
Lift	h3	3000	3100	3200	3700	4100	4400	5000	
	h1	H40	2370	2420	-	2720	2920	3070	3370
Mast retracted	h1	H45 - H50	2421	2471	-	2771	2971	3121	3421
	h4	H50/600	-	-	2620	2870	3070	3220	3520
Mast extended	h4	H40	3795	3895	-	4495	4895	5195	5795
	h4	H45 - H50	3916	4016	-	4616	5016	5316	5916
Free lift	h4	H50/600	-	-	4216	4716	5116	5416	6016
	h2	H40 - H50	150	150	150	150	150	150	150
Overall height and lift height Duplex mast (in mm)									
Lift	h3	3030	3130	3730	4130	-	-	-	
	h1	H40	2325	2375	2675	2875	-	-	-
Mast retracted	h1	H45 - H50	2376	2426	2726	2926	-	-	-
	h4	H40	3794	3894	4494	4894	-	-	-
Mast extended	h4	H45 - H50	3946	4046	4646	5046	-	-	-
	h2	H40	1561	1611	1911	2111	-	-	-
Free lift	h2	H45 - H50	1460	1510	1810	2010	-	-	-
	h2	H40	-	-	-	-	-	-	-
Overall height and lift height Triplex mast (in mm)									
Lift	h3	4225	4525	4615	4675	5065	5365	5565	5865
	h1	H40	-	2325	-	2375	-	2625	-
Mast retracted	h1	H45 - H50	-	2376	-	2426	-	2676	-
	h4	H50/600	2376	-	2526	-	2676	-	2876
Mast extended	h4	H40	-	5286	-	5436	-	6126	-
	h4	H45 - H50	-	5441	-	5591	-	6281	-
Free lift	h4	H50/600	5241	-	5631	-	6081	-	6581
	h2	H40	-	1564	-	1614	-	1864	-
Free lift	h2	H45 - H50	-	1460	-	1510	-	1760	-
	h2	H50/600	1360	-	1510	-	1660	-	1860

Figures in mm
 Alternative lift heights available on request